

Trailblazer® 325

Gas or LP Engine-Driven
Welder/AC Generator 

Quick Specs

Industrial Applications

Fabrication
Maintenance
Repair
Structural steel work
Sheet metal
Pipe

Processes

Stick (SMAW)
MIG (GMAW)*
Flux-cored (FCAW)*
RMD®**
Pulsed MIG (GMAW-P)**
DC TIG (GTAW)
Air carbon arc (CAC-A)
cutting and gouging
Rated: 3/16-inch carbons,
Capable: 1/4-inch carbons

Output Range (gas models) DC stick 30–325 A
MIG/flux-cored 10–35 V
DC TIG 10–325 A

Generator Power Output Rated at 104°F (40°C) (gas models)
12,000 watts peak, 10,500 watts continuous

Electronic Fuel Injection (EFI) (option)

Uses up to 42 percent less fuel

Excel™ Power (EFI only option)

2,400 watts (120 V, 20 A) 60 Hz pure sine power at all speeds

Battery Charge/Crank Assist (EFI gas only option)

Battery charge 12/24 V, 75 A

Crank assist 12/24 V, 350 A

*With wire feeder. **ArcReach models only with ArcReach Smart Feeder.

Trailblazer welder/generators deliver unbeatable arc performance providing the smoothest, most stable arc in the industry.

The Trailblazer exclusive technologies — Auto-Speed™ and optional Excel™ power — deliver superior runtimes, increased fuel efficiency, and improved welder/generator performance.

No other compact machine in the 300-amp class delivers more welding power or more auxiliary power with better fuel efficiency and less noise — for productive, profitable, quieter jobsites.

ArcReach®

Remote control of the power source without a cord. See page 2.



Trailblazer 325 EFI with optional ArcReach and Excel power shown.



Welder/generator is warranted for three years, parts and labor.
Engine is warranted separately by the engine manufacturer.



Miller Electric Mfg. LLC
An ITW Welding Company
1635 West Spencer Street
P.O. Box 1079
Appleton, WI 54912-1079 USA

Equipment Sales US and Canada
Phone: 866-931-9730
FAX: 800-637-2315
International Phone: 920-735-4554
International FAX: 920-735-4125

MillerWelds.com



Trailblazer® Technologies

Unbeatable arc performance

Dynamic DIG™ technology automatically adjusts the amount of current required to clear a short. Delivers a smoother, more consistent arc that

can be tailored to match the application, material, fit-up and welder technique.



Auto-Speed™ technology

Matches engine speed to load — a Miller exclusive. Get the welding power you need — plus reduced fuel consumption and lower noise levels for a more-profitable, safer jobsite.

Unlike competitive machines that operate at 3,600 rpm (max) under any load, Miller-exclusive Auto-Speed technology responds to weld requirements by automatically adjusting engine speed to one of four rpm levels so the engine never works harder than necessary.

Refueling time and operating costs are reduced, which means more productivity and profitability. Plus everyone on the jobsite gets a better working environment because noise levels and exhaust emissions are lowered.

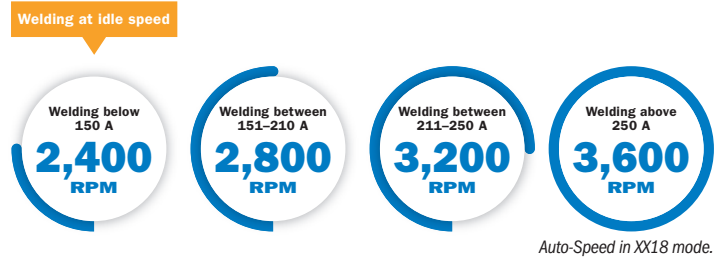

Electronic fuel injection (EFI) (option)

Improve fuel efficiency for maximum productivity and profitability. Adding EFI to your Trailblazer welder/generator adds multiple benefits. With EFI, you'll get faster, more-reliable starts in any weather — no choke adjustments needed. EFI-equipped Trailblazer machines are also up to 42 percent more fuel efficient than standard carbureted models, improving profitability. Plus, refueling less frequently means you'll spend more of your time welding, improving productivity.

Add Excel power to your Trailblazer with EFI, and you'll have the most fuel-efficient compact welder/generator available.

Increased performance at high altitude. Electric fuel pumps are now standard on all EFI models, leading to better performance when operating at altitudes of 5,000 feet or greater.

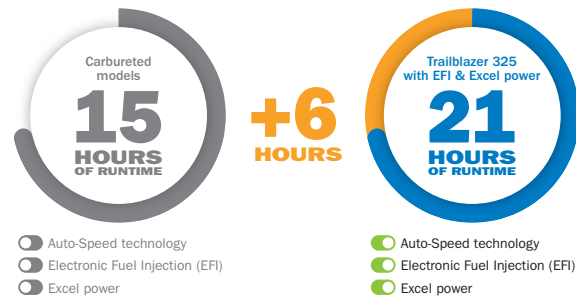

Based on typical usage — 150 amps welding 40% of the time; 20 amps generator power 30% of the time; and idling without load 30% of the time.

Excel™ power (option)

Power at idle — a Miller exclusive. Unlike competitive machines that provide auxiliary power only at 3,600 rpm (max), Excel power delivers a full 2,400 watts (20 A) of 120-volt inverter-based, pure sine wave power at all speeds, including idle. With Excel power you can operate jobsite tools like grinders at quiet, fuel-saving speeds.

Refueling time and operating costs are reduced with Excel power, which means more productivity and profitability. Plus everyone on the jobsite gets a better working environment because noise levels and exhaust emissions are lowered. Excel power — available only from Miller.

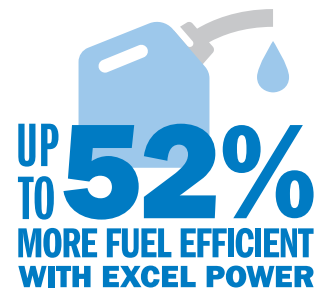

Based on generator-only use for total runtime.

ArcReach® remote control technology (option)

Remote control of the power source without a control cord. An ArcReach system allows you to change weld settings from your ArcReach feeder or remote, saving a trip to the power supply. ArcReach technology uses the existing weld cable to communicate welding control information between

the feeder or remote and the power source. This technology eliminates the need for control cords, and their associated problems and costs.



Battery charge/crank assist (option)

Reduce downtime with battery charge/crank assist capability. Designed and recommended for mechanics or anyone else responsible for a fleet of trucks or equipment. By using your Trailblazer to charge dead batteries or

jump a stubborn engine, you'll keep your crew working and the fleet up and running.

Note: Battery charge/jump cables (300422) must be ordered separately.

Trailblazer® Benefits

Fewer refueling trips

No other gas welder/generator in the 300-amp class lets your crews spend more time working and less time refueling — because only Trailblazer welder/generators provide Auto-Speed™ technology, plus Excel™ power and electronic fuel injection (EFI) options, to deliver maximum runtime.

Maximum cost savings

Less money spent on fuel means more profit for you. Every Trailblazer welder/generator has fuel-saving Auto-Speed technology; add optional Excel power and EFI to save even more on fuel costs and enjoy a combination of advanced, profit-enhancing features that are only available on a Trailblazer welder/generator.

ADD EFI & EXCEL POWER

**ANNUAL FUEL SAVINGS
OVER LEADING COMPETITIVE MACHINE**

\$571

DELIVERS PAYBACK IN 2.5 YEARS

Estimate based on fuel cost of \$2.00 per gallon with machine operating for 25 hours per week for 50 weeks per year under typical usage — 150 amps welding 40% of the time; 20 amps generator power 30% of the time; and idling without load 30% of the time.

Safer, more productive jobsites

Quieter jobsites are safer and more productive because work crews can communicate easier, and work can start earlier and end later — even in noise-sensitive areas. If your jobsite needs a welder/generator, it needs a Trailblazer welder/generator — because no other gas-fueled choice is as quiet.

Optional ArcReach® remote control technology eliminates the need to trace or move heavy secondary weld leads bundled with control cords on the jobsite. Complete remote control of welding processes and parameters improves safety by limiting jobsite movement and reducing slip, trip and fall hazards.



**IT WOULD TAKE
7 TRAILBLAZERS
TO EQUAL THE
SOUND OUTPUT OF
1 COMPETITOR
MACHINE.**

More portable, uses less truck and jobsite space

Trailblazer welder/generators are up to 17 percent smaller and 10 percent lighter than competitive machines — which means moving them is faster and easier, for maximum productivity. And because they take up less space, Trailblazer welder/generators let work trucks carry more equipment and gear — so your work crews can be ready for anything.



**17%
LESS CUBIC SPACE
THAN THE COMPETITION**

Cleaner and stronger generator power

Combined with a 25-horsepower engine, Trailblazer welder/generators offer 12,000 watts of clean, truly usable generator power that is Accu-Rated™, not inflated: tested to deliver uninterrupted peak output for a minimum of 30 seconds for big loads, so you can get more jobs done.

An independent welder and generator power system ensures no interaction between jobsite tools and the welding arc, while advanced generator technology virtually eliminates power spikes and other electrical imperfections — so welds are cleaner and jobsite tools can run without interruption, maximizing quality, productivity and profit.

Runs cooler while operating

Exclusive engine and generator packaging design operates cooler and more efficiently. The engine is rotated towards the front to create more efficient airflow. More efficient airflow and exclusive engine location are significant contributors to reduced sound level and size reduction. Hot air recirculation is eliminated when machine is mounted in tight spots, and internal parts are kept cool for optimal performance.



Specifications (Subject to change without notice.)



Welding Mode	Process	Amp/Volt Ranges	Rated Weld Output at 104°F (40°C)*	Single-Phase Generator Power	Sound Levels at 7 m (23 ft.)	Dimensions	Net Weight**
CC/DC	Stick/TIG	Gas: 10–325 A LP: 10–305 A	Gas: 325 A at 28 V, 100% duty cycle LP: 305 A at 28 V, 100% duty cycle	Peak Gas: 12,000 watts LP: 10,500 watts Continuous Gas: 10,500 watts LP: 10,000 watts Excel™ power (optional) 2,400 watts, 20 A at 120 V, 60 Hz pure generator power at idle speed and while welding	Weld 150 A load: 65 dB (90 Lwa), 325 A load: 73.5 dB (98.5 Lwa) Generator power Excel power: 65 dB (90 Lwa), 12 kW standard power: 73.5 dB (98.5 Lwa)	H: 28 in. (711 mm) H: 32.75 in. (832 mm) <i>(to top of exhaust)</i> W: 20 in. (508 mm) D: 40.5 in. (1,029 mm)	325 gas model 460 lb. (209 kg) 325 LP model 475 lb. (215 kg)
CV/DC	MIG/FCAW	10–35 V					
Battery charge/crank assist (optional)		12/24 V	Charge: 75 A Crank assist: 350 A				

*Rated at sea level. **Net weight without fuel.



Certified by Canadian Standards Association to both the Canadian and U.S. Standards.

Engine Specifications (Engines warranted separately by the engine manufacturer.)

Model	Engine Brand and Warranty	Horsepower (HP)	Type	Weld Speed	Idle Speed	Fuel Capacity	Oil Capacity	Standard Shutdowns
Trailblazer 325*	Kohler CH730, 3-year warranty	23.5 hp at 3,600 rpm	Twin-cylinder, four-cycle overhead valve, air-cooled industrial engine	Auto-Speed™ 2,400, 2,800, 3,200 or 3,600 rpm	2,400 rpm	12 gal. (45 L)	1.5 qt. (1.4 L)	Low oil pressure
Trailblazer 325 EFI*	Kohler ECH730, 3-year warranty	23 hp at 3,600 rpm						
Trailblazer 325 LP** (liquid LP)	Kohler CH730LP, 3-year warranty	23.5 hp at 3,600 rpm						

*Fuel stabilizer is recommended for gas engines that are used infrequently.

**Hose and LP Tank Mounting Assembly (300917) and setup are required.

Performance Data

Weld Fuel Consumption

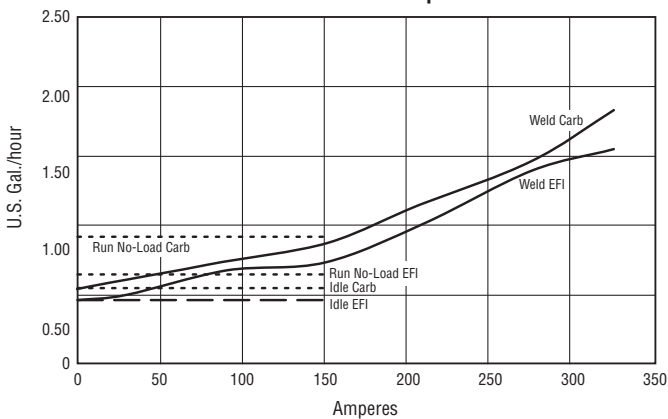

Auxiliary Power Fuel Consumption

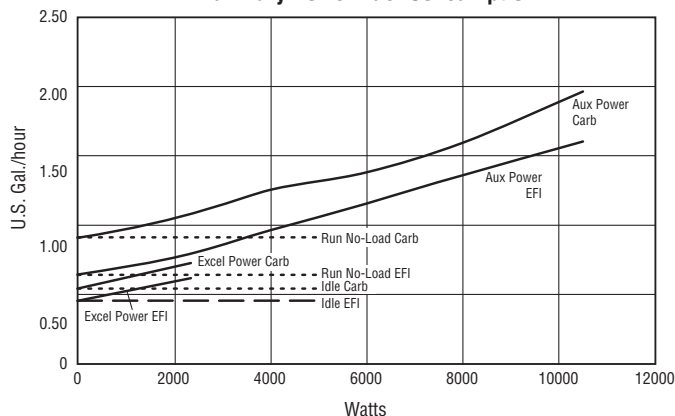

Mounting Specifications

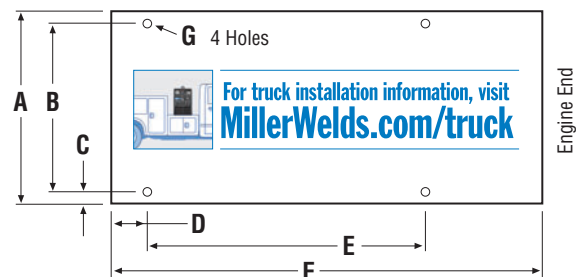

- A. 20 in. (508 mm)
- B. 16.5 in. (419 mm)
- C. 1.75 in. (44.5 mm)
- D. 5.12 in. (130 mm)
- E. 22.3 in. (566 mm)
- F. 40.32 in. (1,024 mm)
- G. .406 in. (10.3 mm) diameter

Function and Benefit Guide

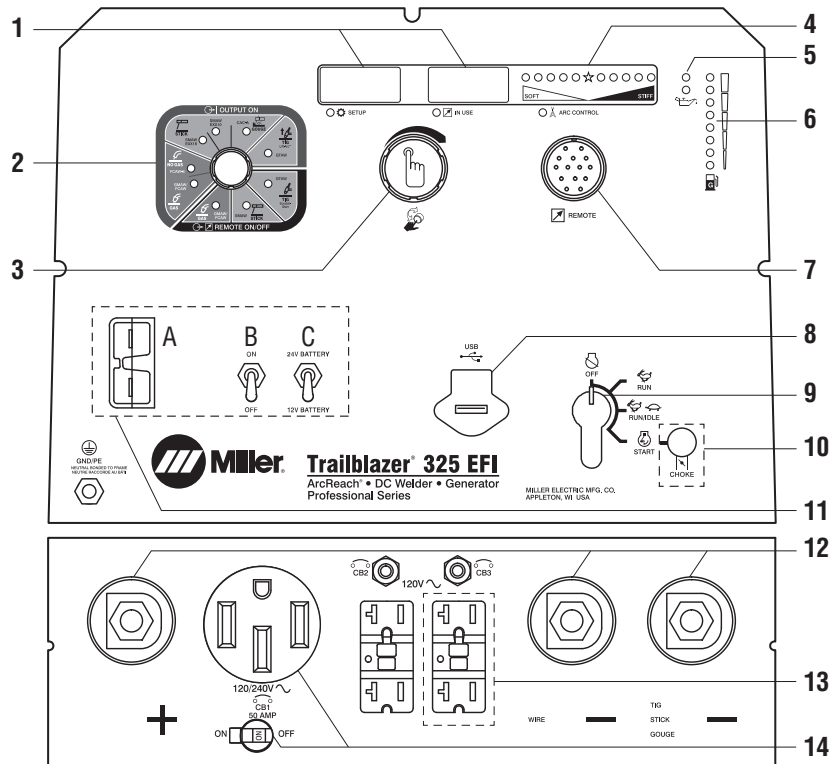

1. Self-calibrating digital meters with SunVision™

- Preset and actual amperage/voltage
- Process settings
- Maintenance functions: hour meter, oil change interval, rpm

2. Weld process selection switch

3. Pushbutton main control knob used for adjusting amperage/voltage, adjusting arc control, and accessing the service menu.

4. Adjustable arc control adjusts DIG when process control is in stick modes and adjusts inductance when process control is in FCAW or MIG modes. The amount of DIG determines how much amperage (heat) varies with stick arc length. Inductance determines the “wetness” of the weld puddle.

5. Maintenance interval reminder. Yellow and red indicator lights let an operator know when the machine is approaching, and finally in need of routine maintenance.

6. Front panel fuel gauge LEDs indicate fuel level. (Gas models only)

7. Standard 14-pin receptacle for simple connection of remote controls and wire feeders. Includes **Auto Remote Sense™** which automatically switches from panel to remote amperage/voltage (A/V) control with remote connected. Eliminates confusion of a panel/remote switch.

8. USB port allows software updates from a USB drive. A summary file of recorded data from the unit will be saved to a USB drive that is inserted.

9. Engine control. Run/idle position adjusts engine to run at lower speeds depending on total power needed for welding.

10. Engine choke control (LP models only) is used for easy engine starting.

11. Optional battery charge/crank assist (factory option, see page 8)

- A. Receptacle: Provides connection to battery charge/crank assist (12 or 24 volt)
- B. On/off switch: Provides simple control of the battery
- C. Voltage switch: Provides simple selection of battery voltage

12. Weld output terminals

13. Optional Excel™ power (factory option, see page 8) provides pure generator power at idle speed and while welding.

Note: If Trailblazer is ordered without Excel power option, unit is shipped with two 20 A, 120 V duplex receptacles with circuit breakers and ground fault.

14. 50 A, 120/240 V receptacle with circuit breaker

Note: For matching plug, order 119172.

Genuine Miller® Options *Available as factory option. See ordering information on back page.

LP Gas*

Liquid LP with regulator. Does not include tanks, brackets or hose from tank to regulator.

Note: Requires Hose and LP Tank Mounting Assembly 300917.

GFCI Receptacles* 300975 Field
Kit contains two GFCI 120 V duplex receptacles.

Electric Fuel Pump* 300976 Field
Recommended for gas engine operations at altitudes above 5,000 feet. Improves engine starting and high-output performance.

Spark Arrestor 300924 Field
Mandatory when operating on California grasslands, brush or forest-covered land, and all national forests. For other areas, check your state and local laws.



Remote Oil Drain and Filter Kit 300923 Field
Front mount for Kohler. Makes servicing easy when engine drive is mounted in tight spots.



Full KVA Adapter Cord 300517 Field
NEMA 14-50P to NEMA 6-50R. Adapts engine drive 120/240 V plug to common Millermatic® and Spectrum® 240 V plug.

Female Receptacle



Full KVA Plug Kit 119172 Field
120/240 V, 50 A plug (NEMA 14-50P) to fit full KVA receptacle.

Order the following from Miller Service Parts.

Engine Tune-Up Kits

230015 Field. Kohler CH730 (gas)
284083 Field. Kohler ECH730 (EFI gas)
252838 Field. Kohler CH7430 (LP)
Includes spark plugs and engine filters.

Genuine Miller® Accessories



Never Flat™ Tires

Available on Bobcat and Trailblazer running gear.

- Eliminate costly jobsite downtime

- Maintain constant tire pressure and will not develop flats
- Protect against punctures
- Preserve maneuverability, even when weighed down with heavy welding cable



Multi-Terrain Running Gear

300913 Gas/LP, with inner tubes
300914 Gas/LP, with Never Flat tires
Includes two heavy-duty 15-inch tires, two 8-inch rubber swivel casters and a heavy-duty handle. Recommended for all surfaces and applications, and is easy to move around the jobsite.

used with running gear, gas cylinder mounting assembly, LP tank mounting assembly, or with trailer.



Hose and LP Tank Mounting Assembly

300917 LP
Designed for use with multi-terrain running gear, protective cage, or by itself. Includes bracket and clamp to

mount 33- and 43-pound tanks horizontally, and hose with fittings to converter. For use with Trailblazer 325 LP only.

Note: Not for use with gas cylinder mounting assembly. Not recommended for use with protective cover.



Off-Road Running Gear

300909 Gas/LP, with inner tubes
300910 Gas/LP, with Never Flat tires
Includes four

heavy-duty 15-inch tires and a rugged handle to provide maximum maneuverability.



Protective Cage with Cable Holders

300921 Gas/LP
Rugged cage with cable holders protects your investment. Can be

used with running gear, gas cylinder mounting assembly, LP tank mounting assembly, or with trailer.



25-foot Battery Charge/Jump Cables with Plug

300422



Off-Road Running Gear with Protective Cage and Never Flat Tires

300912 Gas/LP
Running gear and rugged cage with

cable holders protects your investment and is easy to move around the jobsite.



Gas Cylinder Mounting Assembly

300918 Gas
Designed for use with multi-terrain running gear, protective cage, or by itself. Includes base tray with bottle

bracket, vertical support rack and safety chain.
Note: Not for use with LP tank mounting assembly. Not recommended for use with protective cover.

Protective Covers



300919 For gas models **without** protective cage or running gear (shown)

300920 For gas models **with** protective cage and/or running gear

Heavy-duty, water-resistant and mildew-resistant covers protect and maintain the finish of the welder.

MIG/Flux-cored Welding



ArcReach® SuitCase® 8

951726 With Bernard™ BTB Gun 300 A

951727 With Bernard™ S-Gun™

951728 With Bernard™ Dura-Flux™ gun

ArcReach® SuitCase® 12

951729 With Bernard™ BTB Gun 300 A

951730 With Bernard™ S-Gun™

951731 With Bernard™ Dura-Flux™ gun

Portable feeder designed to run off of arc voltage. When paired with an ArcReach power source, provides remote control of the power source without a control cord — saving time and money. See literature M/6.55.



ArcReach® Smart Feeder 951733

For use with ArcReach models only. Includes drive rolls and Bernard™ PipeWorx 300-15 MIG gun. For MIG, FCAW, and advanced RMD® and pulse processes. See literature M/6.55.



SuitCase® 12RC

Wire Feeder 951580

Lightweight and flexible enough to run wires up to .062-inch diameter. Includes remote voltage control, drive roll kit and

Bernard™ BTB Gun 300 A. See literature M/6.5.



Spoolmatic® 30A

Spool Gun 130831

Air-cooled, 200-amp, one-pound spool gun for aluminum MIG. See literature M/1.73. Requires WC-24 control (**137549**).

XR™ Wire Feeders and Guns

Push-pull system designed to handle difficult-to-feed soft alloy wires such as aluminum. See literature M/1.7 through M/1.74.

Stick (SMAW) Welding

Weld Leads

2/0 Stick Cable Set, 50 ft. (15 m) 173851

Consists of 50-foot (15 m) 2/0 electrode cable with holder, and 50-foot (15 m) work cable with clamp. 350 A, 100% duty cycle.

2/0 Stick Cable Set, 100/50 ft. (30.5/15 m) 043952

Consists of 100-foot (30.5 m) 2/0 electrode cable with holder, and 50-foot (15 m) work cable with clamp. 300 A, 100% duty cycle.

AC TIG (GTAW) Welding



Dynasty® 210 Series

For portable AC/DC TIG. See literature AD/4.81.

Plasma Cutting



Spectrum 375 X-TREME and 625 X-TREME shown.

Spectrum® 375 X-TREME™ 907529

See literature PC/9.2.

Spectrum® 625 X-TREME™ 907579

See literature PC/9.6.

Spectrum® 875 907583

See literature PC/9.8.

The Spectrum 375 X-TREME and 625 X-TREME come complete with protective X-CASE™ (not shown).

Remote Controls



ArcReach® Stick/TIG Remote 301325

When paired with an ArcReach power source, provides remote control of the power source without a control cord — saving time and money. See literature AY/14.5.



Wireless Remote Hand Control 300430

For remote current, voltage and contactor control. Receiver plugs directly into the 14-pin receptacle of Miller machine. 300-foot (91.4 m) operating range.



RHC-14 Hand Control 24221020

Miniature hand control for remote current and contactor control. Dimensions: 4 x 4 x 3.25 inches (102 x 102 x 82 mm). Includes 20-foot (6 m) cord and 14-pin plug.



PRHC-14 Hand Control 195511

Complete current or voltage control brings 120 volts GFCI power to work area in a single cord. Housed in a durable, light aluminum case and includes 125-foot (38 m) cord with plugs.

Extension Cables for 14-Pin Remote Controls

242208025 25 ft. (7.6 m)

242208050 50 ft. (15.2 m)

242208080 80 ft. (24.4 m)

Trailers and Hitches



HWY-Mid Frame Trailer 301438

1,424-pound (646 kg) capacity highway trailer with welded steel tubing frame, heavy-duty axle with roller bearing hubs and leaf-spring suspension. Includes jack stand, fenders, lights, and dual hitch with 2-inch (50 mm) ball hitch and 3-inch (76 mm) lunette eye.

Note: Trailer is shipped unassembled.



Cable Tree 043826

Provides an area to conveniently wrap weld cables and extension cords.



2-In-1 Document/Fire Extinguisher Holder 301236

Stores documents and holds a five-pound fire extinguisher.

Note: Holder shown mounted on trailer. Fire extinguisher not included.

Ordering Information

Equipment and Options	Stock No.	Description	Qty.	Price
Trailblazer® 325	907753	Kohler engine, base model		
	907753001	Kohler engine with GFCI receptacles		
	907753002	Kohler engine with electric fuel pump		
Trailblazer® 325 EFI	907754	Kohler engine with electronic fuel injection		
	907754001	Kohler engine with electronic fuel injection and Excel™ power		
	907754002	Kohler engine with electronic fuel injection, Excel™ power, GFCI receptacles and ArcReach® remote control technology		
Trailblazer® 325 LP	907754003	Kohler engine with electronic fuel injection, Excel™ power and battery charge/crank assist		
	907775	Kohler liquid LP engine with GFCI receptacles		
	907775001	Kohler liquid LP engine with Excel™ power and GFCI receptacles and ArcReach® remote control technology		
Field Options <i>Options listed below can be added to the above packages. Installation is required.</i>				
GFCI Receptacles	300975			
Electric Fuel Pump	300976	Recommended for gas engine operations at altitudes above 5,000 feet		
Spark Arrestor	300924			
Remote Oil Drain and Filter Kit	300923	Front mount for Kohler		
Full KVA Adapter Cord	300517			
Full KVA Plug	119172			
Engine Tune-Up Kits		See page 6. <i>Order from Miller Service Parts</i>		
Accessories				
Off-Road Running Gear	300909	Gas/LP models, with inner tubes		
	300910	Gas/LP models, with Never Flat™ tires		
Off-Road Running Gear with Protective Cage	300912	Gas/LP models, with Never Flat™ tires		
Multi-Terrain Running Gear	300913	Gas/LP models, with inner tubes		
	300914	Gas/LP models, with Never Flat™ tires		
Protective Cage with Cable Holders	300921	Gas/LP models		
Gas Cylinder Mounting Assembly	300918	Gas models. <i>Not for use with LP tank mounting assembly. Not recommended for use with protective cover</i>		
Hose and LP Tank Mounting Assembly	300917	LP models. <i>Not for use with gas cylinder mounting assembly. Not recommended for use with protective cover</i>		
25-foot Battery Charge/Jump Cables with Plug	300422			
Protective Covers		See page 6		
MIG/Flux-cored Welding				
SuitCase® Wire Feeders and ArcReach® Smart Feeder		See page 7		
Spoolmatic® 30A Spool Gun	130831	Requires WC-24 control. See literature M/1.73		
WC-24 Control	137549	See literature M/1.73		
XR™ Wire Feeder Control and Guns		See literature M/1.7 through M/1.74		
Stick Welding		See page 7		
TIG Welding		See page 7		
Plasma Cutting		See page 7		
Remote Controls and Extension Cables		See page 7		
Trailers and Hitches				
HWY-Mid Frame Trailer	301438	Trailer with lights, fenders and dual hitch. For highway use		
Cable Tree	043826	Trailer-mounted cable holder		
2-In-1 Document/Fire Extinguisher Holder	301236	Stores documents and holds a five-pound fire extinguisher		

Date:

Total Quoted Price:

Distributed by:

